

# GU LINE



**cmatic**<sup>®</sup>  
P N E U M A T I C F I T T I N G S

Innesti Rapidi  
Couplings  
Coupleurs  
Kupplungen



GU 20		Innesto rapido DN2,5	Coupling DN2,5	Coupleur DN2,5	Kupplung DN2,5
1	2	3	4	5	
Corpo Body Corps Körper	Otturatore Valve Clapet Ventil	Molle Springs Ressorts Feder	Guarnizioni Seals Joint d'étanchéité Dichtung	Sfere Balls Billes Kugel	Innesti Plugs Embouts Stecker
Ottone UNI EN 12164 CW614N Nichelato Brass UNI EN 12164 CW614N Nickel plated Laiton UNI EN 12164 CW614N Nickelé Ms Vernickelt UNI EN 12164 CW614N	Ottone UNI EN 12164 CW614N Brass UNI EN 12164 CW614N Laiton UNI EN 12164 CW614N Messing UNI EN 12164 CW614N	Acciaio Inox AISI 302 Stainless Steel AISI 302 Acier Inox AISI 302 Edelstahl AISI 302	NBR NBR NBR NBR	Acciaio Inox AISI 420 Stainless Steel AISI 420 Acier Inox AISI 420 Edelstahl AISI 420	Ottone UNI EN 12164 CW614N Nichelato Brass UNI EN 12164 CW614N Nickel plated Laiton UNI EN 12164 CW614N Nickelé Ms Vernickelt UNI EN 12164 CW614N

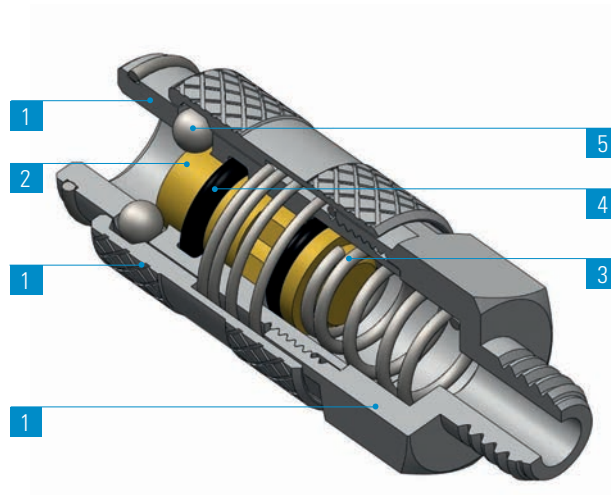

Campi di applicazione:  
Impianti pneumatici.

Application fields:  
Pneumatic circuits.

Domaines d'application:  
Circuits pneumatiques.

Anwendungsbereiche:  
Pneumatische Anlagen.

### GU 20-11

Innesto rapido con filetto maschio

Male coupling

Coupleur mâle

Einschraubkupplung

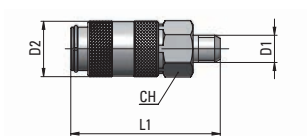

Type	D1	D2	L1	CH	g
11 00 M5	M5x0,8	10	27,5	9	10
11 00 18	G1/8	10	29	12	14

### GU 20-12

Innesto rapido con filetto femmina

Female coupling

Coupleur femelle

Aufschraubkupplung

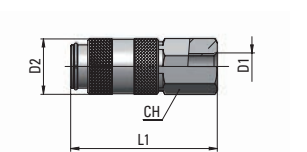

Type	D1	D2	L1	CH	g
12 00 M5	M5x0,8	10	27	9	11
12 00 18	G1/8	10	30,5	12	15

**GU 20-13**

Innesto rapido con portagomma

Coupling with hose connection

Coupleur avec douille cannelée

Kupplung mit Schlauchtülle

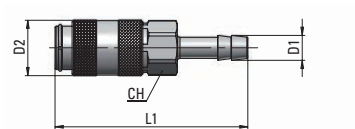

Type	Ø Tubo	D1	D2	L1	CH	g $\Delta$
13 03 00	3	3,6	10	35,5	9	9
13 04 00	4	4,6	10	35,5	9	10

**GU 20-15**

Innesto rapido con calzamento

Coupling with nut fitting

Coupleur avec raccord à écrou

Kupplung mit Überwurfverschraubung

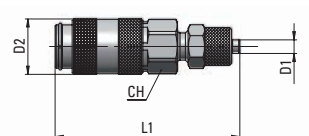

Type	D1	D2	L1	CH	g $\Delta$
15 04 00	4x2,5	10	34	9	11
15 06 00	6x4	10	35	9	13

**GU 20-20**

Innesto con filetto maschio

Male plug

Embout mâle

Einschraubverschlußnippel

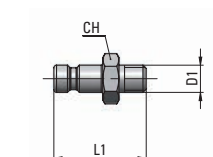

Type	D1	L1	CH	g $\Delta$
20 00 M5	M5x0,8	17	8	2
20 00 18	G1/8	20	12	6

**GU 20-21**

Innesto con filetto femmina

Female plug

Embout femelle

Aufschraubverschlußnippel

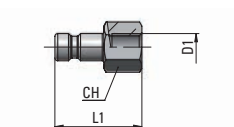

Type	D1	L1	CH	g $\Delta$
21 00 M5	M5x0,8	16	8	3
21 00 18	G1/8	19	12	6

**GU 20-22**

Innesto con portagomma

Plug with hose connection

Embout avec douille cannelée

Schlauchtülle

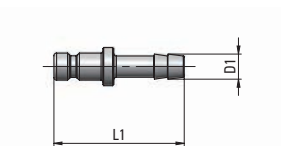

Type	Ø Tubo	D1	L1	g $\Delta$
22 03 00	3	3,6	24	2
22 04 00	4	4,6	24	2

**GU 20-23**

Innesto con raccordo a calzamento

Plug with nut fitting

Embout avec raccord à écrou

Verschlußstülle mit Überwurfmutter

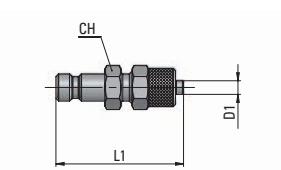

Type	D1	L1	CH	g $\Delta$
23 04 00	4x2,5	23,5	7	4
23 06 00	6x4	24,5	8	6

GU 21	Innesto rapido DN5	Coupling DN5	Coupleur DN5	Kupplung DN5	
1	2	3	4	5	
Corpo Body Corps Körper	Otturatore Valve Clapet Ventil	Molle Springs Ressorts Feder	Guarnizioni Seals Joint d'étanchéité Dichtung	Sfere Balls Billes Kugel	Innesti Plugs Embouts Stecker
Ottone UNI EN 12164 CW614N Nichelato Brass UNI EN 12164 CW614N Nickel plated Laiton UNI EN 12164 CW614N Nickelé Ms Vernickelt UNI EN 12164 CW614N	Ottone UNI EN 12164 CW614N Nichelato Brass UNI EN 12164 CW614N Nickel plated Laiton UNI EN 12164 CW614N Nickelé Ms Vernickelt UNI EN 12164 CW614N	Acciaio Inox AISI 302 Stainless Steel AISI 302 Acier Inox AISI 302 Edelstahl AISI 302	NBR NBR NBR NBR	Acciaio Inox AISI 420 Stainless Steel AISI 420 Acier Inox AISI 420 Edelstahl AISI 420	Ottone UNI EN 12164 CW614N Nichelato Brass UNI EN 12164 CW614N Nickel plated Laiton UNI EN 12164 CW614N Nickelé Ms Vernickelt UNI EN 12164 CW614N



-20°C ÷ 80°C



0 ÷ 15 bar



5 mm



600 NI/min  
(6 bar · Δp = 1bar)

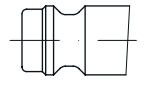
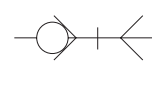

Scala 1:1  
Scale 1:1  
Echelle 1:1  
Maßstab 1:1

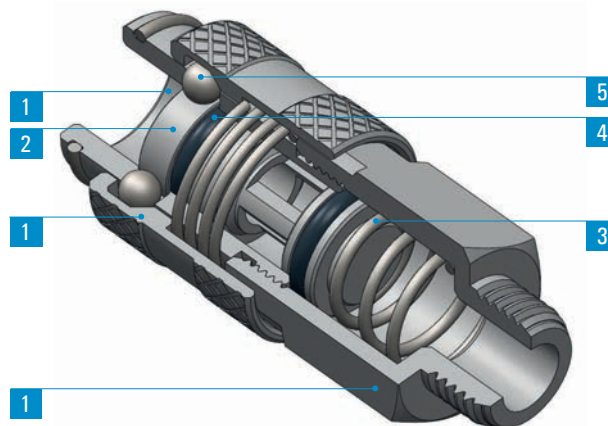

Campi di applicazione:  
Impianti pneumatici.

Application fields:  
Pneumatic circuits.

Domaines d'application:  
Circuits pneumatiques.

Anwendungsbereiche:  
Pneumatische Anlagen.

### GU 21-11

Innesto rapido con filetto maschio

Male coupling

Coupleur mâle

Einschraubkupplung

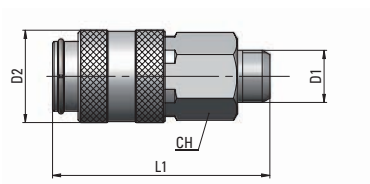

Type	D1	D2	L1	CH	g $\Delta$
11 00 18	G1/8	17	40	14	33,5
11 00 14	G1/4	17	42	17	43,6

### GU 21-12

Innesto rapido con filetto femmina

Female coupling

Coupleur femelle

Aufschraubkupplung

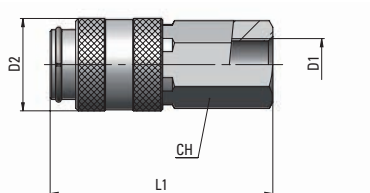

Type	D1	D2	L1	CH	g $\Delta$
12 00 18	G1/8	17	41	14	37
12 00 14	G1/4	17	46	17	53

**GU 21-13**

Innesto rapido con portagomma

Coupling with hose connection

Coupleur avec douille cannelée

Kupplung mit Schlauchtülle

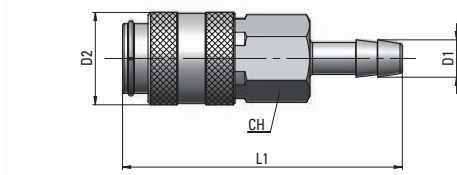

Type	Ø Tubo	D1	D2	L1	CH	g ΔΔ
13 04 00	4	4.9	17	51,5	14	34
13 06 00	6	6.9	17	51,5	14	35,1

**GU 21-15**

Innesto rapido con calzamento

Coupling with nut fitting

Coupleur avec raccord à écrou

Kupplung mit Überwurfverschraubung

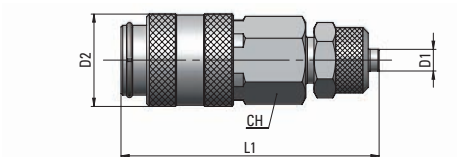

Type	D1	D2	L1	CH	g ΔΔ
15 06 00	6x4	17	47,5	14	38
15 08 00	8x6	17	48,5	14	39,7

**GU 21-20**

Innesto con filetto maschio

Male plug

Embout mâle

Einschraubverschußnippel

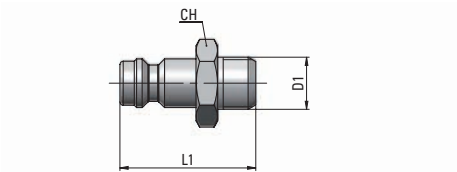

Type	D1	L1	CH	g ΔΔ
20 00 18	G1/8	25	14	11,4
20 00 14	G1/4	27	17	19

**GU 21-21**

Innesto con filetto femmina

Female plug

Embout femelle

Aufschraubverschußnippel

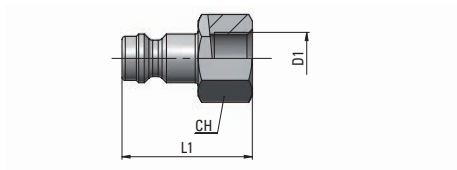

Type	D1	L1	CH	g ΔΔ
21 00 18	G1/8	24	14	13,3
21 00 14	G1/4	27	17	19,7

**GU 21-22**

Innesto con portagomma

Plug with hose connection

Embout avec douille cannelée

Schlauchtülle

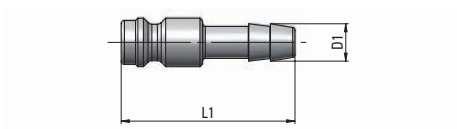

Type	Ø Tubo	D1	L1	g ΔΔ
22 04 00	4	4.9	32	5,8
22 06 00	6	6.9	32	7,2

**GU 21-23**

Innesto con raccordo a calzamento

Plug with nut fitting

Embout avec raccord à écrou

Verschußstülle mit Überwurfmutter

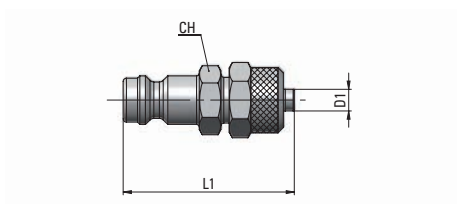

Type	D1	L1	CH	g ΔΔ
23 06 00	6x4	31,5	11	15,1
23 08 00	8x6	32,5	13	20,2

**GU 21-24**

Innesto con molla di protezione

Plug with hose protection spring

Embout avec ressort protection tube

Verschlussstülle mit Knickschutzfeder

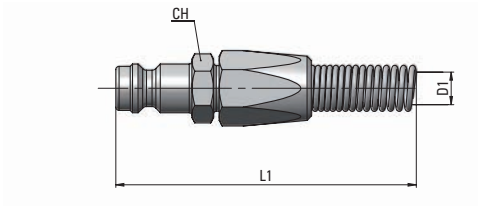

Type	D1	L1	CH	g 
24 06 00	6x4	110	11	23,9
24 08 00	8x6	120	13	30,5

Innesto rapido DN7,4	Coupling DN7,4	Coupleur DN7,4	Kupplung DN7,4
1	2	3	4
Corpo Body Corps Körper	Otturatore Valve Clapet Ventil	Molle Springs Ressorts Feder	Guarnizioni Seals Joint d'étanchéité Dichtung
Sfere Balls Billes Kugel	Innesti Plugs Embouts Stecker	Acciaio Inox AISI 302 Stainless Steel AISI 302 Acier Inox AISI 302 Edelstahl AISI 302	NBR NBR NBR NBR
Ottone UNI EN 12164 CW614N Nichelato Brass UNI EN 12164 CW614N Nickel plated Laiton UNI EN 12164 CW614N Nickelé Ms Vernickelt UNI EN 12164 CW614N	Ottone UNI EN 12164 CW614N Nichelato Brass UNI EN 12164 CW614N Nickel plated Laiton UNI EN 12164 CW614N Nickelé Ms Vernickelt UNI EN 12164 CW614N	Acciaio Inox AISI 420 Stainless Steel AISI 420 Acier Inox AISI 420 Edelstahl AISI 420	Ottone UNI EN 12164 CW614N Nichelato Brass UNI EN 12164 CW614N Nickel plated Laiton UNI EN 12164 CW614N Nickelé Ms Vernickelt UNI EN 12164 CW614N

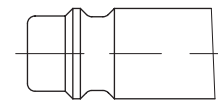
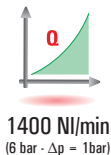

Profilo Europeo  
European Profile  
Profil européen  
Europäisches Profil

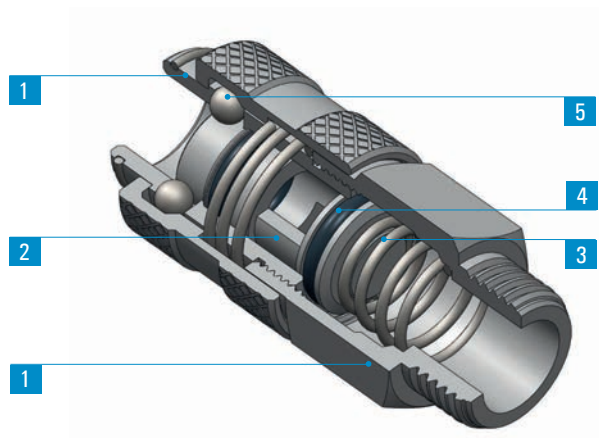

Campi di applicazione:  
Impianti pneumatici.

Application fields:  
Pneumatic circuits.

Domaines d'application:  
Circuits pneumatiques.

Anwendungsbereiche:  
Pneumatische Anlagen.

**GU 26-11**

Innesto rapido con filetto maschio

Male coupling

Coupleur mâle

Einschraubkupplung

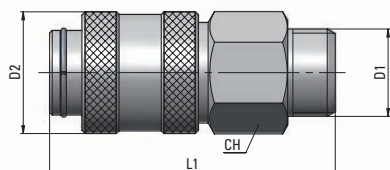

Type	D1	D2	L1	CH	g $\Delta$
11 00 14	G1/4	23	51.5	20	82
11 00 38	G3/8	23	51.5	20	89
11 00 12	G1/2	23	51.5	24	107

**GU 26-12**

Innesto rapido con filetto femmina

Female coupling

Coupleur femelle

Aufschraubkupplung

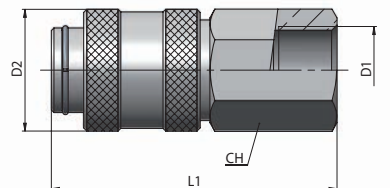

Type	D1	D2	L1	CH	g $\Delta$
12 00 14	G1/4	23	56.5	20	91
12 00 38	G3/8	23	58	20	90
12 00 12	G1/2	23	59.5	24	106

### GU 26-13

Innesto rapido con portagomma

Coupling with hose connection

Coupleur avec douille cannelée

Kupplung mit Schlauchtülle

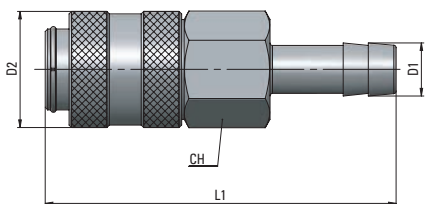

Type	Ø Tubo	D1	D2	L1	CH	g $\Delta$
13 06 00	6	7,5	23	69,5	20	90
13 09 00	9	10,5	23	69,5	20	91
13 13 00	13	14,5	23	69,5	20	89

### GU 26-15

Innesto rapido con calzamento

Coupling with nut fitting

Coupleur avec raccord à écrou

Kupplung mit Überwurfverschraubung

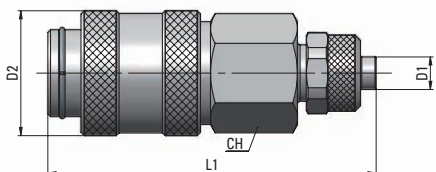

Type	D1	D2	L1	CH	g $\Delta$
15 08 00	8x6	23	58	20	90
15 10 00	10x8	23	60	20	91

### GU 26-20

Innesto con filetto maschio

Male plug

Embout mâle

Einschraubverschlußnippel

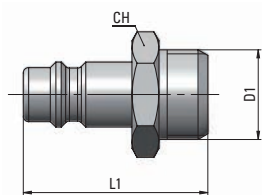

Type	D1	L1	CH	g $\Delta$
20 00 14	G1/4	33	17	22
20 00 38	G3/8	34	20	29
20 00 12	G1/2	37	24	50

### GU 26-21

Innesto con filetto femmina

Female plug

Embout femelle

Aufschraubverschlußnippel

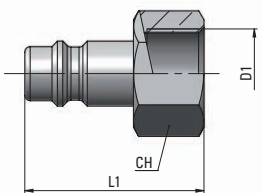

Type	D1	L1	CH	g $\Delta$
21 00 14	G1/4	33	17	23,5
21 00 38	G3/8	33	20	26
21 00 12	G1/2	37	24	39

### GU 26-22

Innesto con portagomma

Plug with hose connection

Embout avec douille cannelée

Schlauchtülle

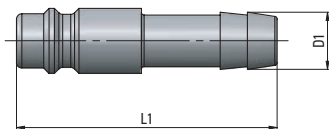

Type	Ø Tubo	D1	L1	g $\Delta$
22 06 00	6	7,5	48	14
22 08 00	8	9,5	48	16
22 09 00	9	10,5	48	18
22 10 00	10	11,5	48	20
22 13 00	13	14,5	48	34

### GU 26-23

Innesto con raccordo a calzamento

Plug with nut fitting

Embout avec raccord à écrou

Verschlußtülle mit Überwurfmutter

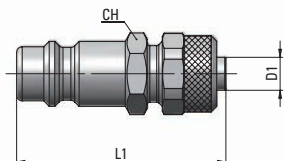

Type	D1	L1	CH	g $\Delta$
23 06 00	6x4	37,5	13	20
23 08 00	8x6	38,5	13	22
23 10 00	10x8	41,5	15	29



**GU 26-24**

Innesto con molla di protezione

Plug with hose protection spring

Embout avec ressort protection tube

Verschlussstütle mit Knickschutzfeder

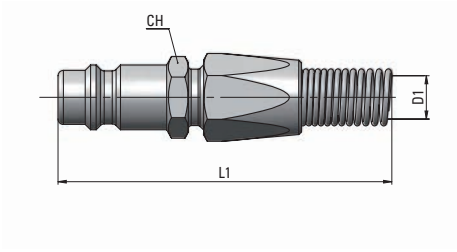

Type	D1	L1	CH	g $\Delta$
24 06 00	6x4	120	13	30
24 08 00	8x6	125	13	34
24 10 00	10x8	135	15	52

GU 10-11	Innesto rapido multipresa	Multi socket quick coupling	Coupleur multiprofil	Multiprofilkupplung	GU 11
1	2	3	4	5	GU 11
Corpo Body Corps Körper	Otturatore Valve Clapet Ventil	Molle Springs Ressorts Feder	Guarnizioni Seals Joint d'étanchéité Dichtung	Sfere Balls Billes Kugel	Innesti Plugs Embouts Stecker
Ottone UNI EN 12164 CW614N Nichelato Brass UNI EN 12164 CW614N Nickel plated Laiton UNI EN 12164 CW614N Nickelé Ms Vernickelt UNI EN 12164 CW614N	Ottone UNI EN 12164 CW614N Nichelato Brass UNI EN 12164 CW614N Nickel plated Laiton UNI EN 12164 CW614N Nickelé Ms Vernickelt UNI EN 12164 CW614N	Acciaio Inox AISI 302 Stainless Steel AISI 302 Acier Inox AISI 302 Edelstahl AISI 302	NBR NBR NBR NBR	Acciaio Inox AISI 420 Stainless Steel AISI 420 Acier Inox AISI 420 Edelstahl AISI 420	Ottone Nichelato Brass ickel plated Laiton Nickelé Ms Vernickelt



-20°C + 80°C



0 + 15 bar

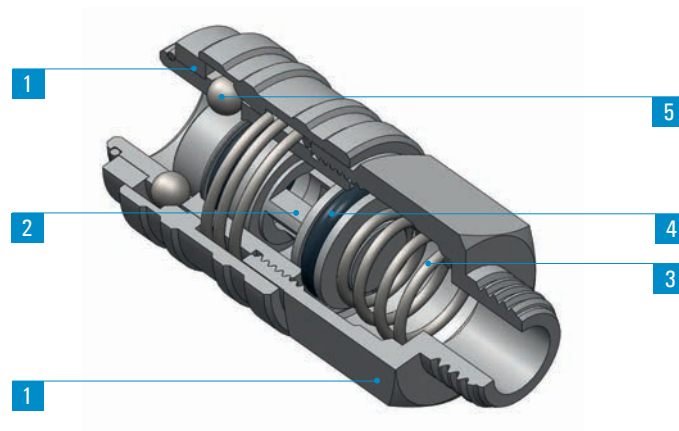

Intercambiabilità con i profili Suitable with following plugs profiles Interchangeable avec les suivants profils Austauschbar mit folgenden Profilen	Portata Flow rate Débit Durchfluß	(6 bar - Δp = 1bar)
---	--	---------------------

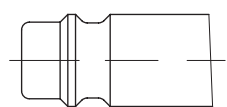

Profilo Europeo  
European Profile  
Profil européen  
Europäisches Profil

820

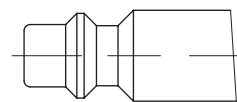

Profilo ISO 6150 B  
ISO 6150 B Profile  
Profil ISO 6150 B  
ISO 6150 B Profil

715

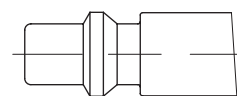

Profilo Svedese  
Standard Swedisch Profile  
Profil Standard Suédois  
Standard schwedisches Profil

725

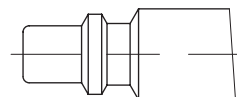

Profilo Italiano  
Standard Italian Profile  
Profil Standard Italien  
Standard Italienisches Profil

670

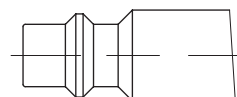

Profilo MIL C4109  
MIL C4109 Profile  
Profil MIL C4109  
MIL C4109 Profil

715

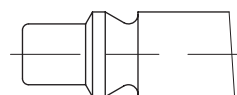

Profilo ARO 210  
ARO 210 Profile  
Profil ARO 210  
ARO 210 Profil

705

Scala 1:1 - Scale 1:1 - Echelle 1:1 - Maßstab 1:1

## GU 10-11

Innesto rapido con filetto maschio

Male coupling

Coupleur mâle

Einschraubkupplung

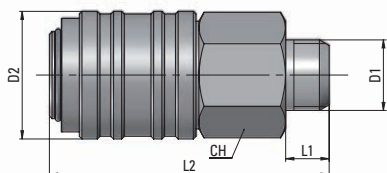

Type	D1	D2	L1	L2	CH	g $\Delta\Delta$
11 00 14	G1/4	23,5	10	51,5	20	90
11 00 38	G3/8	23,5	11	51,5	20	93
11 00 12	G1/2	23,5	11	51,5	24	118

## GU 10-12

Innesto rapido con filetto femmina

Female coupling

Coupleur femelle

Aufschraubkupplung

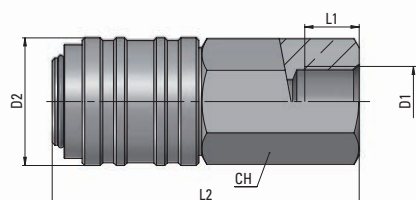

Type	D1	D2	L1	L2	CH	g $\Delta\Delta$
12 00 14	G1/4	23,5	10	56,5	20	109
12 00 38	G3/8	23,5	11	58	20	103
12 00 12	G1/2	23,5	11	59,5	24	134

## GU 10-13

Innesto rapido con portagomma

Coupling with hose connection

Coupleur avec douille cannelée

Kupplung mit Schlauchtülle

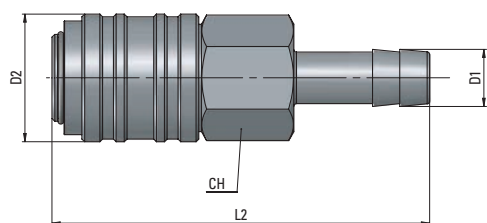

Type	D1	D2	L2	CH	g $\Delta\Delta$
13 06 00	6	23,5	69,5	20	91
13 09 00	9	23,5	69,5	20	93
13 13 00	13	23,5	69,5	20	107

## GU 11-20

Innesto Italia con filetto maschio

Male plug, italian profile

Embout mâle, profil italien

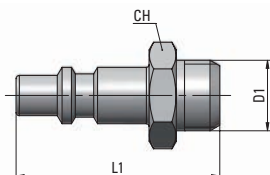
Einschraubverschußnippel,  
italienisches Profil

Type	D1	L1	CH	g $\Delta\Delta$
20 00 14	G1/4	37,5	14	19,1
20 00 38	G3/8	40	19	28
20 00 12	G1/2	40,5	24	36,2

## GU 11-21

Innesto Italia con filetto femmina

Female plug, italian profile

Embout femelle, profil italien

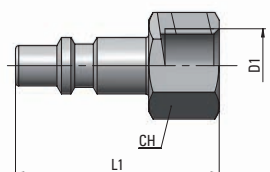
Aufschraubverschußnippel,  
italienisches Profil

Type	D1	L1	CH	g $\Delta\Delta$
21 00 14	G1/4	39	17	23
21 00 38	G3/8	41	19	26
21 00 12	G1/2	44	25	51,1