

CILINDRI TONDI CP95 Ø32-63 CP95 ROUND CYLINDERS Ø32-63



Cilindri dal Ø32 al Ø63

Altamente resistenti con testate cianfrinate e camicia in acciaio inox. Disponibili in versione magnetica o non, con o senza ammortizzo regolabile, semplice o doppio effetto, a stelo singolo o passante. Ampia gamma di accessori. Su richiesta sono fornibili in varie esecuzioni speciali ed in versione conforme alla direttiva 2014/34/UE ATEX.

Cylinders from Ø32 to Ø63

Highly resistant with crimped covers and stainless steel barrel. Available with or without magnet, with or without adjustable cushioning, single or double acting, single or through piston rod. Wide range of mounting accessories. Special versions are available. On request compliant with 2014/34/UE ATEX directive.

VERSIONE VERSION

CSE		CDEMA	
CSEM		CDEP	
CDE		CDEMP	
CDEM		CDEAP	
CDEA		CDEMAP	

INFORMAZIONI TECNICHE TECHNICAL INFORMATION

Testate Covers	Alluminio anodizzato Anodized Aluminium
Tubo Tube	Acciaio inox AISI304 AISI304 Stainless steel
Pistone Piston	Alluminio Aluminium
Guarnizioni Seals	Poliuretano Polyurethane
Boccola guida Guiding bush	Bronzo sinterizzato Sintered bronze
Stelo Piston rod	Acciaio inox AISI303 AISI303 Stainless steel
Pressione MAX MAX pressure	10 bar
Temperatura di impiego Working temperature	-35°C +80°C con aria secca -35°C +80°C with dry air
Fluido Working fluid	Aria compressa filtrata e lubrificata e non Filtered and lubricated or not compressed air

CHIAVI DI CODIFICA CYLINDERS KEY CODE

Versione Version		Diametro Diameter	Corsa Stroke	Guarnizioni Seals
CSE	Semplice effetto molla anteriore non magnetico Single acting front spring non magnetic	32	0...1000	- Standard
CSEM	Semplice effetto molla anteriore magnetico Single acting front spring magnetic	40		V Guarnizioni FKM FKM seals
CDE	Doppio effetto non magnetico Double acting non magnetic	50		VG Guarnizione stelo FKM FKM rod seal
CDEM	Doppio effetto magnetico Double acting magnetic	63		
CDEA	Doppio effetto con ammortizzo regolabile non magnetico Double acting with adjustable cushioning non magnetic			
CDEMA	Doppio effetto con ammortizzo regolabile magnetico Double acting with adjustable cushioning magnetic			
CDEP	Doppio effetto stelo passante non magnetico Double acting through rod non magnetic			
CDEMP	Doppio effetto stelo passante magnetico Double acting through rod magnetic			
CDEAP	Doppio effetto stelo passante con ammortizzo regolabile non magnetico Double acting through rod with adjustable cushioning non magnetic			
CDEMAP	Doppio effetto stelo passante con ammortizzo regolabile magnetico Double acting through rod with adjustable cushioning magnetic			

CORSE STANDARD CILINDRO DOPPIO EFFETTO STANDARD STROKES DOUBLE ACTING CYLINDER

Ø (mm)	Corse standard (mm) Standard strokes (mm)										
	10	25	40	50	80	100	125	160	200	250	300
32	10	25	40	50	80	100	125	160	200	250	300
40	10	25	40	50	80	100	125	160	200	250	300
50	10	25	40	50	80	100	125	160	200	250	300
63	10	25	40	50	80	100	125	160	200	250	300

CORSE STANDARD CILINDRO SEMPLICE EFFETTO STANDARD STROKES SINGLE ACTING CYLINDER

Ø (mm)	Corse standard (mm) Standard strokes (mm)		
	10	25	50
32	10	25	50
40	10	25	50
50	10	25	50
63	10	25	50







FORZE TEORICHE A 6 BAR THEORETICAL FORCES AT 6 BAR



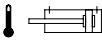
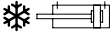

Ø (mm)	Forza di spinta (N) Thrust force (N)	Forza di trazione (N) Traction force (N)
32	482	414
40	754	633
50	1178	989
63	1869	1681

FORZE TEORICHE DELLE MOLLE THEORETICAL SPRING FORCES

Ø (mm)	Molla anteriore Front spring					
	Corsa Stroke 10		Corsa Stroke 25		Corsa Stroke 50	
	F1(N)	F2(N)	F1(N)	F2(N)	F1(N)	F2(N)
32	57	62	51	62	40	62
40	98	105	86	105	64	105
50	147	158	130	158	101	158
63	147	158	130	158	101	158

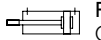
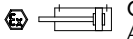
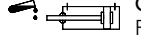
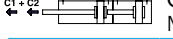
VARIANTI VARIANTS

Simbolo Symbol	Caratteristiche Features
	Resistente alle alte temperature -10...+150°C Heat-resistant -10...+150°C
	Resistente alle basse temperature -40...+80°C Low temperature resistant -40...+80°C
	Stelo prolungato Piston rod extension
	Basso attrito Low friction
	Raschia stelo duro in poliester Hard wiper in polyester
	Stelo in acciaio inox Stainless steel piston rod
	Lubrificazione FDA FDA lubrication

Simbolo Symbol	Caratteristiche Features
	Filettature e steli su richiesta Custom made thread or piston rod
	Certificazione ATEX ATEX certification
	Guarnizione stelo ad elevata resistenza chimica Rod seal with increased chemical resistance
	Configurazione tandem a più posizioni Multi position configuration
	Configurazione tandem a doppia spinta Double thrust tandem configuration
	Configurazione tandem contrapposti anteriore Front opposed tandem configuration
	Configurazione tandem contrapposti posteriore Rear opposed tandem configuration

CILINDRI TONDI CP95 Ø32-63 CP95 ROUND CYLINDERS Ø32-63

SEMPLICE EFFETTO
SINGLE ACTING

CSEØ/...

CSEMØ/...

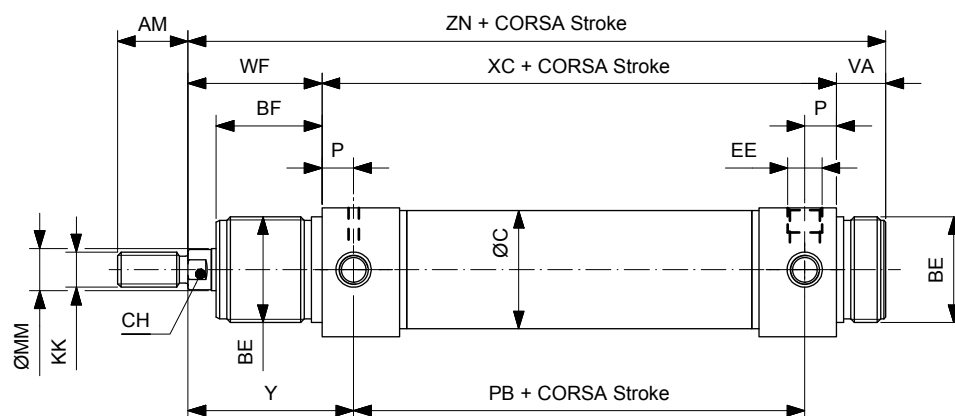
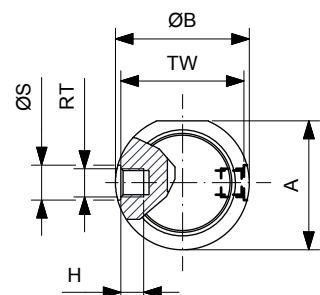

Ø	A	ØB	AM	BE	BF	EE	KK	TW	H	ØS	RT	ØMM	PB	VA	WF	Y	ZN	ØC	P	XC	CH
32	36.5	38	20	M30X1.5	30	1/8"G	M10x1.5	35	6.5	10	M8X1	12	78	14	38	47	148	33.6	9	96	10
40	44	46	24	M38x1.5	35	1/4"G	M12x1.75	42	8	12	M10x1	16	89	16	45	57	174	41.6	12	113	13
50	55	57	32	M45x1.5	38	1/4"G	M16x2	53	10	16	M12x1.5	20	96	18	50	62	188	52.4	12	120	17
63	67.5	70	32	M45x1.5	38	3/8"G	M16x2	66	17	16	M14x1.5	20	98	18	50	63	192	65.4	13	124	17

DOPPIO EFFETTO
DOUBLE ACTING

CDEØ/...

CDEMØ/...

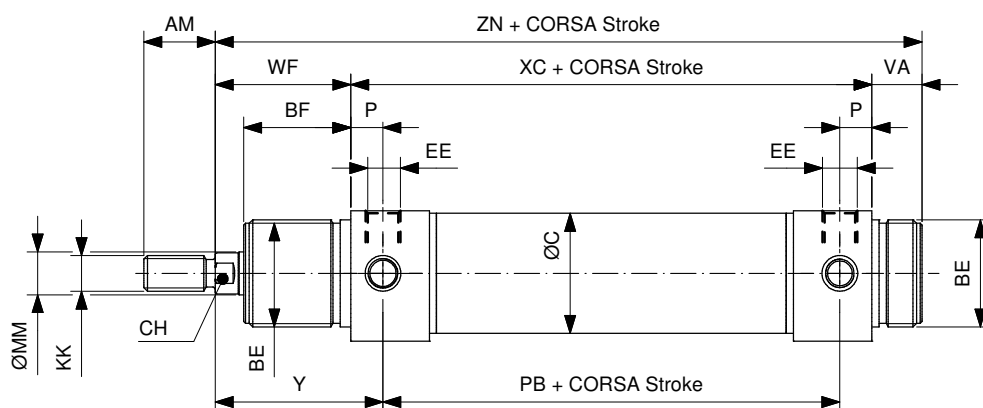
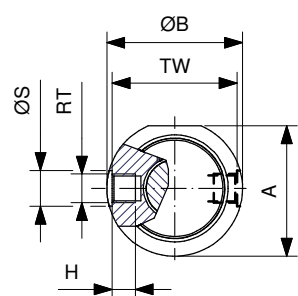

Ø	A	ØB	AM	BE	BF	EE	KK	TW	H	ØS	RT	ØMM	PB	VA	WF	Y	ZN	ØC	P	XC	CH
32	36.5	38	20	M30X1.5	30	1/8"G	M10x1.5	35	6.5	10	M8X1	12	78	14	38	47	148	33.6	9	96	10
40	44	46	24	M38x1.5	35	1/4"G	M12x1.75	42	8	12	M10x1	16	89	16	45	57	174	41.6	12	113	13
50	55	57	32	M45x1.5	38	1/4"G	M16x2	53	10	16	M12x1.5	20	96	18	50	62	188	52.4	12	120	17
63	67.5	70	32	M45x1.5	38	3/8"G	M16x2	66	17	16	M14x1.5	20	98	18	50	63	192	65.4	13	124	17

DOPPIO EFFETTO PASSANTE
DOUBLE ACTING THROUGH PISTON ROD

CDEPØ/...

CDEMPØ/...

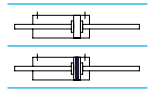
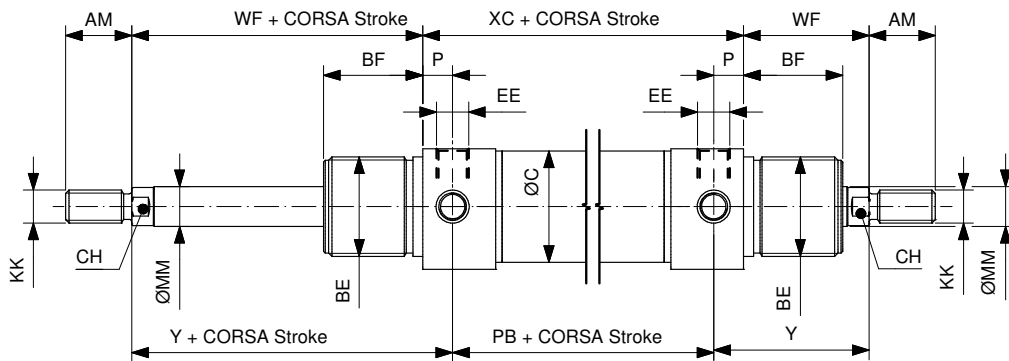
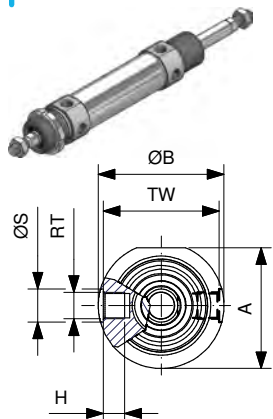

Ø	A	ØB	AM	BE	BF	EE	KK	TW	H	ØS	RT	ØMM	PB	WF	Y	ØC	P	XC	CH
32	36.5	38	20	M30X1.5	30	1/8"G	M10x1.5	35	6.5	10	M8X1	12	78	38	47	33.6	9	96	10
40	44	46	24	M38x1.5	35	1/4"G	M12x1.75	42	8	12	M10x1	16	89	45	57	41.6	12	113	13
50	55	57	32	M45x1.5	38	1/4"G	M16x2	53	10	16	M12x1.5	20	96	50	62	52.4	12	120	17
63	67.5	70	32	M45x1.5	38	3/8"G	M16x2	66	17	16	M14x1.5	20	98	50	63	65.4	13	124	17

DOPPIO EFFETTO AMMORTIZZATO
DOUBLE ACTING CUSHIONED

CDEAØ/...

CDEMAØ/...

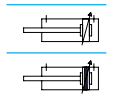
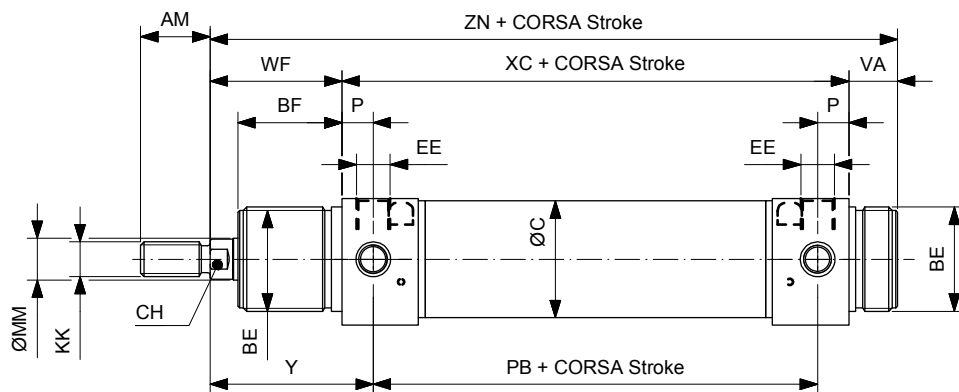
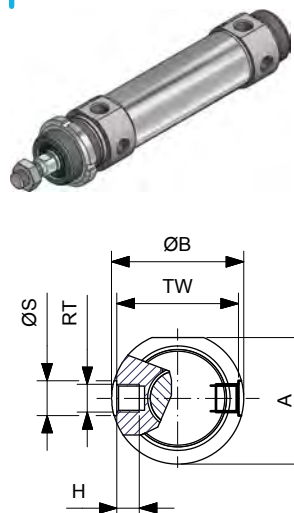

Ø	A	ØB	AM	BE	BF	EE	KK	TW	H	ØS	RT	ØMM	PB	VA	WF	Y	ZN	ØC	P	XC	CH
32	36.5	38	20	M30X1.5	30	1/8"G	M10x1.5	35	6.5	10	M8X1	12	78	14	38	47	148	33.6	9	96	10
40	44	46	24	M38x1.5	35	1/4"G	M12x1.75	42	8	12	M10x1	16	89	16	45	57	174	41.6	12	113	13
50	55	57	32	M45x1.5	38	1/4"G	M16x2	53	10	16	M12x1.5	20	96	18	50	62	188	52.4	12	120	17
63	67.5	70	32	M45x1.5	38	3/8"G	M16x2	66	17	16	M14x1.5	20	98	18	50	63	192	65.4	13	124	17

CILINDRI TONDI CP95 Ø32-63 CP95 ROUND CYLINDERS Ø32-63

DOPPIO EFFETTO AMMORTIZZATO PASSANTE
DOUBLE ACTING CUSHIONED THROUGH PISTON ROD

CDEAPØ/...

CDEMAPØ/...

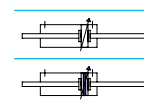
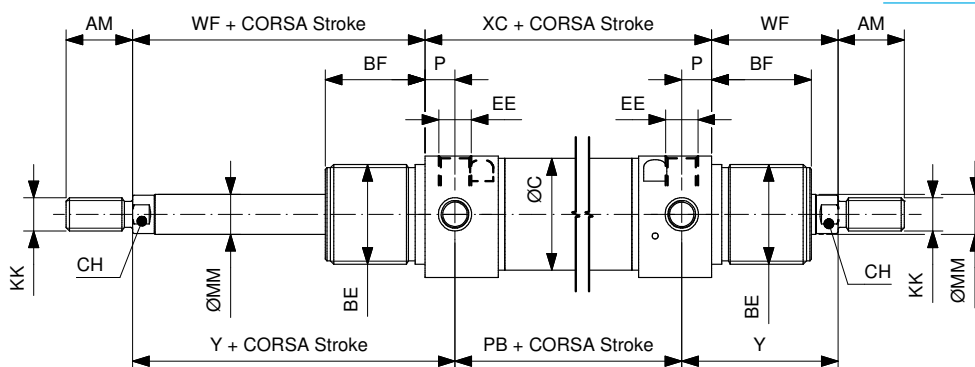
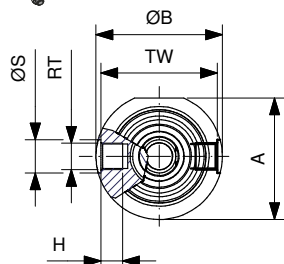

Ø	A	ØB	AM	BE	BF	EE	KK	TW	H	ØS	RT	ØMM	PB	WF	Y	ØC	P	XC	CH
32	36.5	38	20	M30X1.5	30	1/8"G	M10x1.5	35	6.5	10	M8X1	12	78	38	47	33.6	9	96	10
40	44	46	24	M38x1.5	35	1/4"G	M12x1.75	42	8	12	M10x1	16	89	45	57	41.6	12	113	13
50	55	57	32	M45x1.5	38	1/4"G	M16x2	53	10	16	M12x1.5	20	96	50	62	52.4	12	120	17
63	67.5	70	32	M45x1.5	38	3/8"G	M16x2	66	17	16	M14x1.5	20	98	50	63	65.4	13	124	17

ACCESSORI DI FISSAGGIO MOUNTING ACCESSORIES

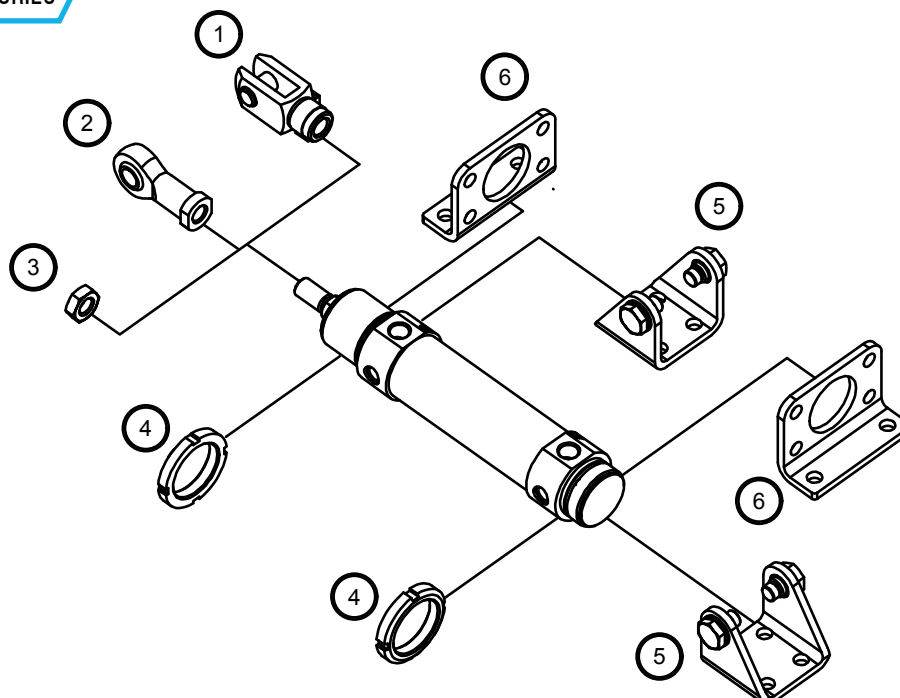

Descrizione Description	Acciaio Steel	Acciaio inox Stainless steel
1 Forcella / Clevis	131	147
2 Testa a snodo / Rod end	132	148
3 Dado per stelo / Piston rod nut	130	146
4 Ghiera / Slotted nut	130	147
5 Cerniera / Hinge (MP3)	144	154
6 Piedino flangia / Foot flange	144	154
7 Giunto autoallineante / Self-aligning joint	131	-