

CILINDRI ISO 15552 PROFILATI Ø32-125 ISO 15552 PROFILED CYLINDERS Ø32-125



Cilindri costruiti a norma ISO 15552 in versione con tubo profilato. Caratterizzato dal design pulito e da grande resistenza e precisione di montaggio. Disponibili in versione magnetica o non, con o senza ammortizzo regolabile, a stelo singolo o passante. Ampia gamma di accessori. Su richiesta sono fornibili in varie esecuzioni speciali ed in versione conforme alla direttiva 2014/34/UE ATEX.

ISO 15552 cylinders, profiled tube version. Featuring a clean design, high resistance and mounting precision. Available with or without magnet, with or without adjustable cushioning, single or through piston rod. Wide range of mounting accessories. Special versions are available. On request compliant with 2014/34/UE ATEX directive.

VERSIONE VERSION

CDE		CDEP	
CDEM		CDEMP	
CDEA		CDEAP	
CDEMA		CDEMAP	

INFORMAZIONI TECNICHE TECHNICAL INFORMATION

Testate Covers	Alluminio pressofuso verniciato Painted die-casted aluminium
Tubo Tube	Alluminio anodizzato Anodized aluminium
Guarnizioni Seals	Poliuretano - NBR Polyurethane - NBR
Boccola guida Guiding bush	Bronzo sinterizzato Sintered bronze
Stelo Piston rod	Acciaio cromato Chromium coated steel
Pressione MAX MAX pressure	10 bar
Temperatura di impiego Working temperature	-20°C +80°C con aria secca -20°C +80°C with dry air
Fluido Working fluid	Aria compressa filtrata e lubrificata e non Filtered and lubricated or not compressed air

CHIAVI DI CODIFICA CYLINDERS KEY CODE

Versione Version		Diametro Diameter	Corsa Stroke	Tipo costruttivo Design Type	Stelo Piston rod	Guarnizioni Seals
CDE	Doppio effetto non magnetico Double acting non magnetic	32	0...2700	X ISO 15552 standard ISO 15552 standard	- Acciaio cromato Chrome plated steel	- Standard
CDEM	Doppio effetto magnetico Double acting magnetic	40			I Acciaio inox AISI 304 AISI 304 Stainless steel	V Guarnizioni FKM FKM seals
CDEA	Doppio effetto con ammortizzo regolabile non magnetico Double acting with adjustable cushioning non magnetic	50				VG Guarnizione stelo FKM FKM rod seal
CDEMA	Doppio effetto con ammortizzo regolabile magnetico Double acting with adjustable cushioning magnetic	63				
CDEP	Doppio effetto stelo passante non magnetico Double acting through rod non magnetic	80				
CDEMP	Doppio effetto stelo passante magnetico Double acting through rod magnetic	100				
CDEAP	Doppio effetto stelo passante con ammortizzo regolabile non magnetico Double acting through rod with adjustable cushioning non magnetic	125				
CDEMAP	Doppio effetto stelo passante con ammortizzo regolabile magnetico Double acting through rod with adjustable cushioning magnetic					







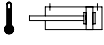
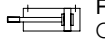
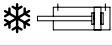
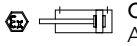

CORSE STANDARD STANDARD STROKES

Ø (mm)	Corse standard (mm) Standard strokes (mm)													
32	10	25	40	50	80	100	125	160	200	250	300	320	400	500
40	10	25	40	50	80	100	125	160	200	250	300	320	400	500
50	10	25	40	50	80	100	125	160	200	250	300	320	400	500
63	10	25	40	50	80	100	125	160	200	250	300	320	400	500
80	10	25	40	50	80	100	125	160	200	250	300	320	400	500
100	10	25	40	50	80	100	125	160	200	250	300	320	400	500
125	10	25	40	50	80	100	125	160	200	250	300	320	400	500

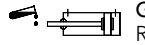
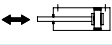
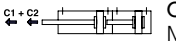
FORZE TEORICHE A 6 BAR THEORETICAL FORCES AT 6 BAR

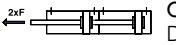
Ø (mm)	Forza di spinta (N) Thrust force (N)	Forza di trazione (N) Traction force (N)
32	482	414
40	754	633
50	1178	989
63	1869	1681
80	3014	2720
100	4710	4416
125	7359	6877

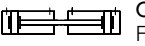
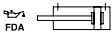
VARIANTI VARIANTS

Simbolo Symbol	Caratteristiche Features	Simbolo Symbol	Caratteristiche Features
	Resistente alle alte temperature -10...+150°C Heat-resistant -10...+150°C		Filettature e steli su richiesta Custom made thread or piston rod
	Resistente alle basse temperature -40...+80°C Low temperature resistant -40...+80°C		Certificazione ATEX ATEX certification
	Stelo prolungato Piston rod extension		Guarnizione stelo ad elevata resistenza chimica Rod seal with increased chemical resistance
	Basso attrito Low friction		Configurazione tandem a più posizioni Multi position configuration
	Raschia stelo duro in poliestere Hard wiper in polyester		Configurazione tandem a doppia spinta Double thrust tandem configuration
	Stelo in acciaio inox Stainless steel piston rod		Configurazione tandem contrapposti anteriore Front opposed tandem configuration
	Lubrificazione FDA FDA lubrication		Configurazione tandem contrapposti posteriore Rear opposed tandem configuration

CILINDRI ISO 15552 PROFILATI Ø32-125 ISO 15552 PROFILED CYLINDERS Ø32-125

DOPIO EFFETTO DOUBLE ACTING

CDEØ/...X

CDEMØ/...X

CDEAØ/...X

CDEMAØ/...X

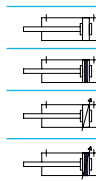
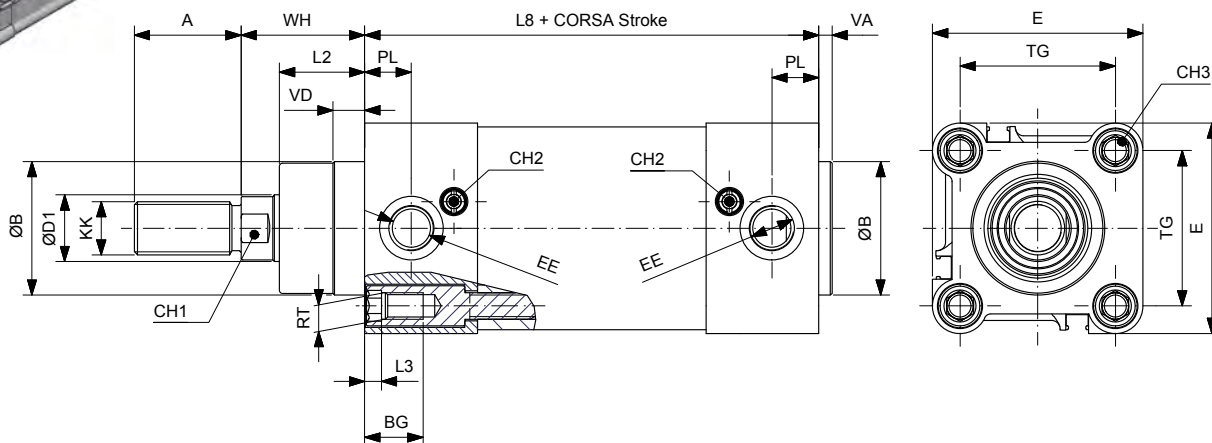
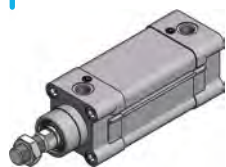

Ø	ØD1	KK	A	ØB	VD	VA	L2	RT	BG	L3	TG	EE	PL	WH	L8	E	CH1	CH2	CH3
32	12	M10x1.25	22	30	9.5	4	18	M6	16.5	5	32.5	1/8"G	12.5	26	94	47	10	3	6
40	16	M12x1.25	24	35	9.5	4	22	M6	16.5	5	38	1/4"G	14	30	105	54	13	3	6
50	20	M16x1.5	32	40	9.5	4	25.5	M8	17.5	5	46.5	1/4"G	14	37	106	63	17	3	8
63	20	M16x1.5	32	45	9.5	4	25	M8	17.5	5	56.5	3/8"G	16.5	37	121	74	17	3	8
80	25	M20x1.5	40	45	10	4	35	M10	17.5	//	72	3/8"G	17	46	128	93.5	22	4	6
100	25	M20x1.5	40	55	10	4	38	M10	17.5	//	89	1/2"G	18	51	138	110	22	4	6
125	32	M27x2	54	60	11	6	46	M12	20.5	//	110	1/2"G	18	65	160	137.5	27	4	8

DOPIO EFFETTO PASSANTE DOUBLE ACTING THROUGH PISTON ROD

CDEPØ/...X

CDEMPØ/...X

CDEAPØ/...X

CDEMAPØ/...X

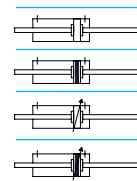
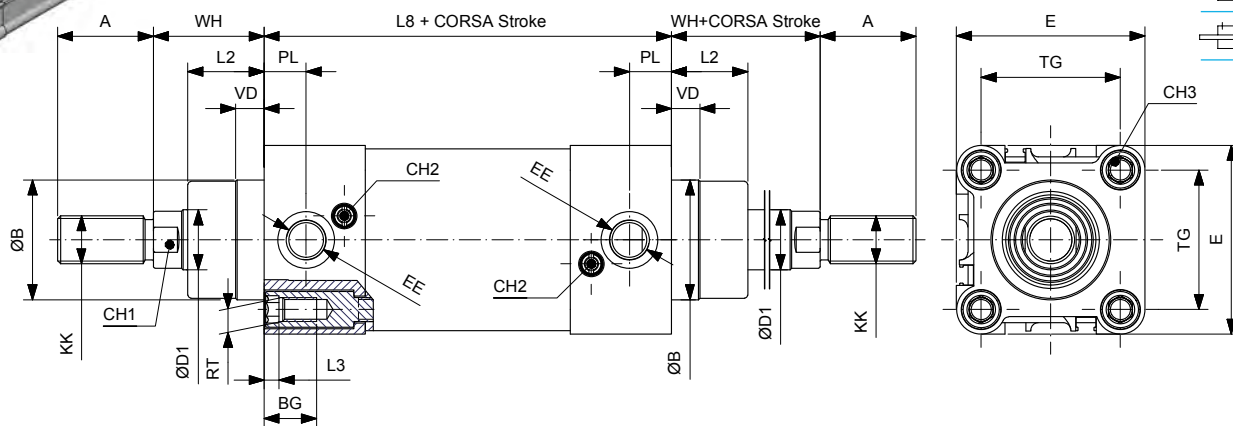
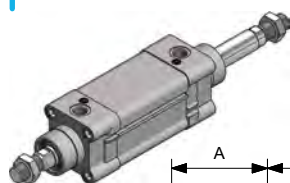

Ø	ØD1	KK	A	ØB	VD	L2	RT	BG	L3	TG	EE	PL	WH	L8	E	CH1	CH2	CH3
32	12	M10x1.25	22	30	9.5	18	M6	16.5	5	32.5	1/8"G	12.5	26	94	47	10	3	6
40	16	M12x1.25	24	35	9.5	22	M6	16.5	5	38	1/4"G	14	30	105	54	13	3	6
50	20	M16x1.5	32	40	9.5	25.5	M8	17.5	5	46.5	1/4"G	14	37	106	63	17	3	8
63	20	M16x1.5	32	45	9.5	25	M8	17.5	5	56.5	3/8"G	16.5	37	121	74	17	3	8
80	25	M20x1.5	40	45	10	35	M10	17.5	-	72	3/8"G	17	46	128	93.5	22	4	6
100	25	M20x1.5	40	55	10	38	M10	17.5	-	89	1/2"G	18	51	138	110	22	4	6
125	32	M27x2	54	60	11	46	M12	20.5	-	110	1/2"G	18	65	160	137.5	27	4	8

ACCESSORI DI FISSAGGIO MOUNTING ACCESSORIES

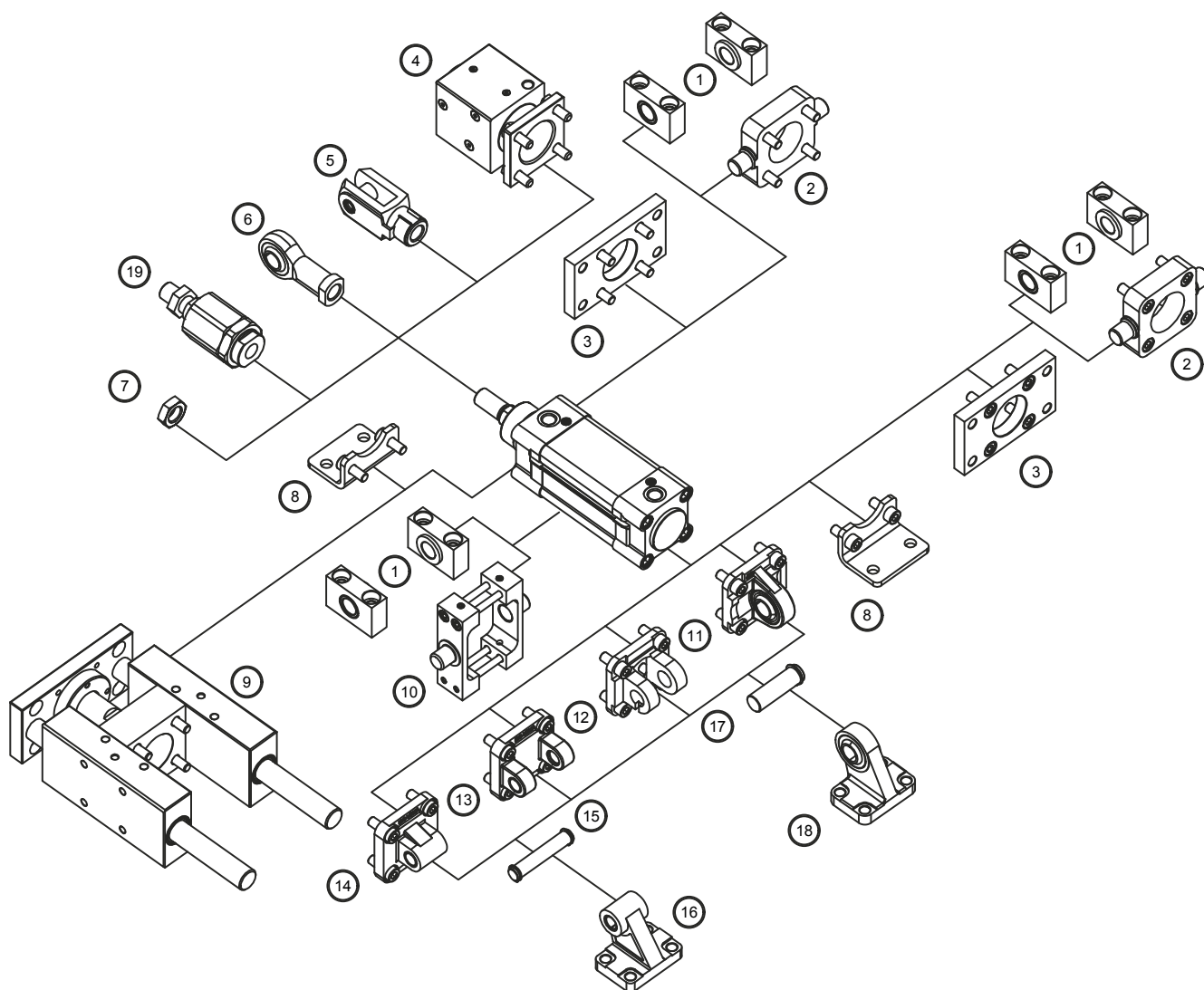

Descrizione Description	Alluminio Alluminium	Acciaio Steel	Acciaio inox Stainless steel
1 Supporto per cerniera intermedia / Support for intermediate hinge (AT4)	-	141	-
2 Cerniera oscillante anteriore-posteriore / Front-rear trunnion (MT5 / MT6)	-	141	-
3 Flangia / Flange (MF1-MF2)	-	139	152
4 Bloccastelo / Rod lock	126	-	-
5 Forcella / Clevis	-	131	147
6 Testa a snodo / Rod end	-	132	148
7 Dado per aste / Piston rod nut	-	130	146
8 Piedino basso / Low-rise pedestal (MS1)	-	138	152
9 Unità di guida / Guide unit	122	-	-
10 Cerniera intermedia per cilindri profilati / Intermediate hinge for profile cylinder (MT4)	-	139	-
11 Cerniera maschio snodata / Male hinge with spherical bearing (MP6)	137	143	-
12 Cerniera femmina stretta per snodo sferico AB6 / Clevis braket, spherical eye, straight AB6	136	142	-
13 Cerniera femmina / Female hinge (MP2)	134	142	150
14 Cerniera maschio / Male hinge (MP4)	135	-	151
15 Perno per cerniera femmina / Pivot for female hinge (AA4)	-	135	150
16 Articolazione a squadra / Square joint (AB7)	137	-	151
17 Perno per cerniera snodata AA6 / Pivot pin, spherical bearing AA6	-	136	-
18 Articolazione a squadra con testina snodata DIN 648 K / Square joint with spherical head DIN 648 K	-	138	-
19 Giunto autoallineante / Self-aligning joint	-	131	-